













ANTENNAS | WLAN-60 SERIES

UNI-DIRECTIONAL, DUAL-BAND WI-FI ANTENNA

2400 - 2500 MHz, 3300 - 3800 MHz & 5000 - 6000 MHz, 18 dBi



						
2400 – 2500 MHz; 3300 – 3800 MHz; 5000 – 6000 MHz	18 dBi	Increase x Mb/s	Uni-Directional	2.4-2.5 GHz 5.0-6.0 GHz	3.5 GHz CBRS	
						
IoT	Machine to Machine	IP 65	-40°C to +70°C	Fire Resistant		

- **Dual-band 2.4 GHz and 5 GHz Wi-Fi antenna**
- **Directional antenna with high gain**
- **Compliant with IEEE 802.11b/g/n and 802.11ac wireless standard**
- **Covers the 3.5 GHz CBRS band for future 5G applications**
- **Vandal and water-resistant enclosure (IP 65)**



APPLICATION AREAS

Product Overview

The WLAN-60 antenna is dual-band Wi-Fi antenna, developed by Poynting Antennas. The WLAN-60 antenna is a linear high gain, dual band antenna in one enclosure. The antenna can connect to any Wi-Fi access point whether it is older Wi-Fi technology or new dual band Wi-Fi technology. The antennas can therefore be used to resolve channel saturation and provide the ultimate in Wi-Fi performance and flexibility. This means that the antenna can be used for point to point links where there is an abundance of RF noise and cluttered environments.

The antenna operates in the two Wi-Fi frequency bands (2.4 GHz and 5 GHz), offering excellent utilization of the radio spectrum. The antenna has a maximum gain of 13dBi in the 2.4GHz band and 18dBi in the 5GHz band, which offers the best performance with reliable connections. The antenna also covers the 3.5 GHz CBRS band, which will be used for future 5G technologies with a peak gain of 15dBi. The housing is made of ABS which is a high impact resistant plastic and is also resistant to acids and other chemicals that may occur in industrial plants. The antenna can be opened on the side where an SMA female connector is placed. You can then feed the cable through the bypass gland, which means you do not have to join the antenna cable to extension cables. This eliminates connector losses and the need for taping and waterproofing the connectors for an outdoor installation.

Features

- Dual-band Wi-Fi antenna for 2.4 GHz and 5 GHz
- High gain directional antenna
- Covers 3.5 GHz CBRS band for future 5G applications
- Robust and weather resistant
- Lightweight design and easy installation

Application Areas

- Small business
- Building sites and open cast mines
- Production facilities and factories
- M2M and IoT applications
- Areas with large amounts of machinery (cluttered environments)



Frequency Bands

The WLAN-60 is a directional antenna that works from | 2400 – 2500 MHz | | 3300 – 3800 MHz | and | 5000 – 6000 MHz |

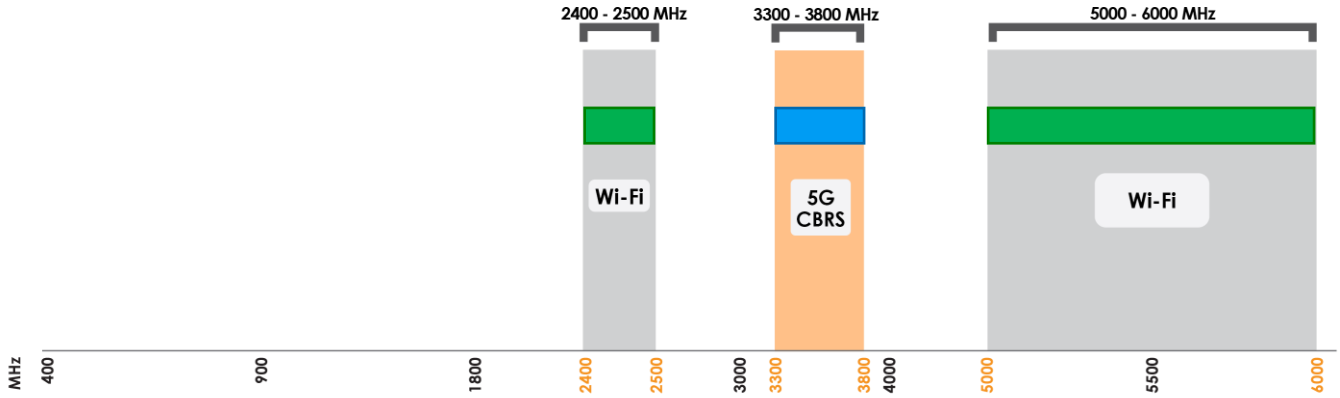

Indicates the CBRS/5G bands on which WLAN-60 works Indicates the WI-FI bands on which WLAN-60 works

Antenna Overview

Ports	1
SISO / MIMO	SISO
Frequency Bands	2400 – 2500 MHz 3300 – 3800 MHz 5000 – 6000 MHz
Polarisation	Linear Vertical
Peak Gain	18 dBi
Coax Cable Type	N/A
Coax Cable Length	N/A
Connector Type	SMA (F)

**The connector is factory mounted to the antenna*

Electrical Specifications

Frequency bands:	2400 – 2500 MHz 3300 – 3800 MHz 5000 – 6000 MHz
Gain (max):	13 dBi @ 2400-2500 MHz 15 dBi @ 3300-3800 MHz 18 dBi @ 5000-6000 MHz
VSWR:	<2.5:1
Feed power handling:	10 W
Input impedance:	50 Ohm (nominal)
Polarisation:	Linear Vertical
Coax cable loss:	N/A
DC short:	Yes

Product Box Contents

Antenna:	A-WLAN-0060-V1
Mounting bracket:	Cast aluminium swivel bracket

Ordering Information

Commercial name:	WLAN-60
Order product code:	A-WLAN-0060-V1
EAN number:	6009710923986

Mechanical Specifications

Product dimensions	240 mm x 240 mm x 60 mm
Packaged dimensions:	260 mm x 280 mm x 80 mm
Weight:	0.76 Kg
Packaged weight:	1.334 Kg
Radome material:	ABS (Halogen Free)
Radome colour:	Cool Gray (1C)
Mounting Type:	Wall and Pole Mount

Environmental Specifications, Certification & Approvals

Wind Survival:	≤160 km/h
Temperature Range (Operating):	-40°C to +70°C
Environmental Conditions:	Outdoor/Indoor
Water ingress protection ratio/standard:	IP 65
Salt Spray:	MIL-STD 810F/ASTM B117
Operating Relative Humidity:	Up to 98%
Storage Humidity:	5% to 95% - non-condensing
Storage Temperature:	-40°C to +70°C
Enclosure Flammability Rating:	UL 94-HB
Impact resistance:	IK 08
Product Safety & Environmental:	Complies with CE and RoHS standards



Antenna Performance Plots

VSWR

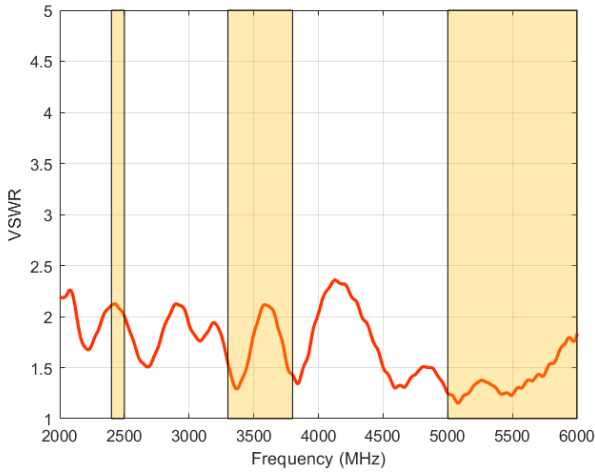

GAIN (EXCLUDING CABLE LOSS)

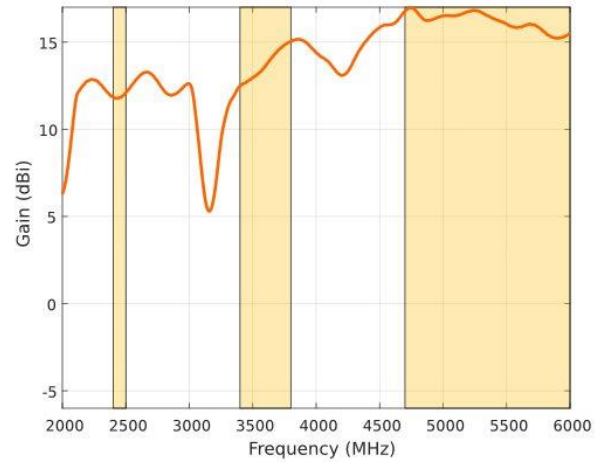

Voltage Standing Wave Ratio (VSWR)

VSWR is a measure of how efficiently radio-frequency power is transmitted from a power source, through a transmission line, into a load. In an ideal system, 100% of the energy is transmitted which corresponds to a VSWR of 1:1.

The WLAN-60 delivers superior performance across all bands with a VSWR of <2.5:1.

Gain* in dBi

18 dBi is the peak gain across all bands from 2400-2500 MHz, 3300-3800 MHz and 5000-6000MHz.

Gain @ 2400 – 2500 MHz:	13 dBi
Gain @ 3300 – 3800 MHz:	15 dBi
Gain @ 5000 – 6000 MHz:	18 dBi

**Antenna gain measured with polarisation aligned standard antenna*

Technical Drawings

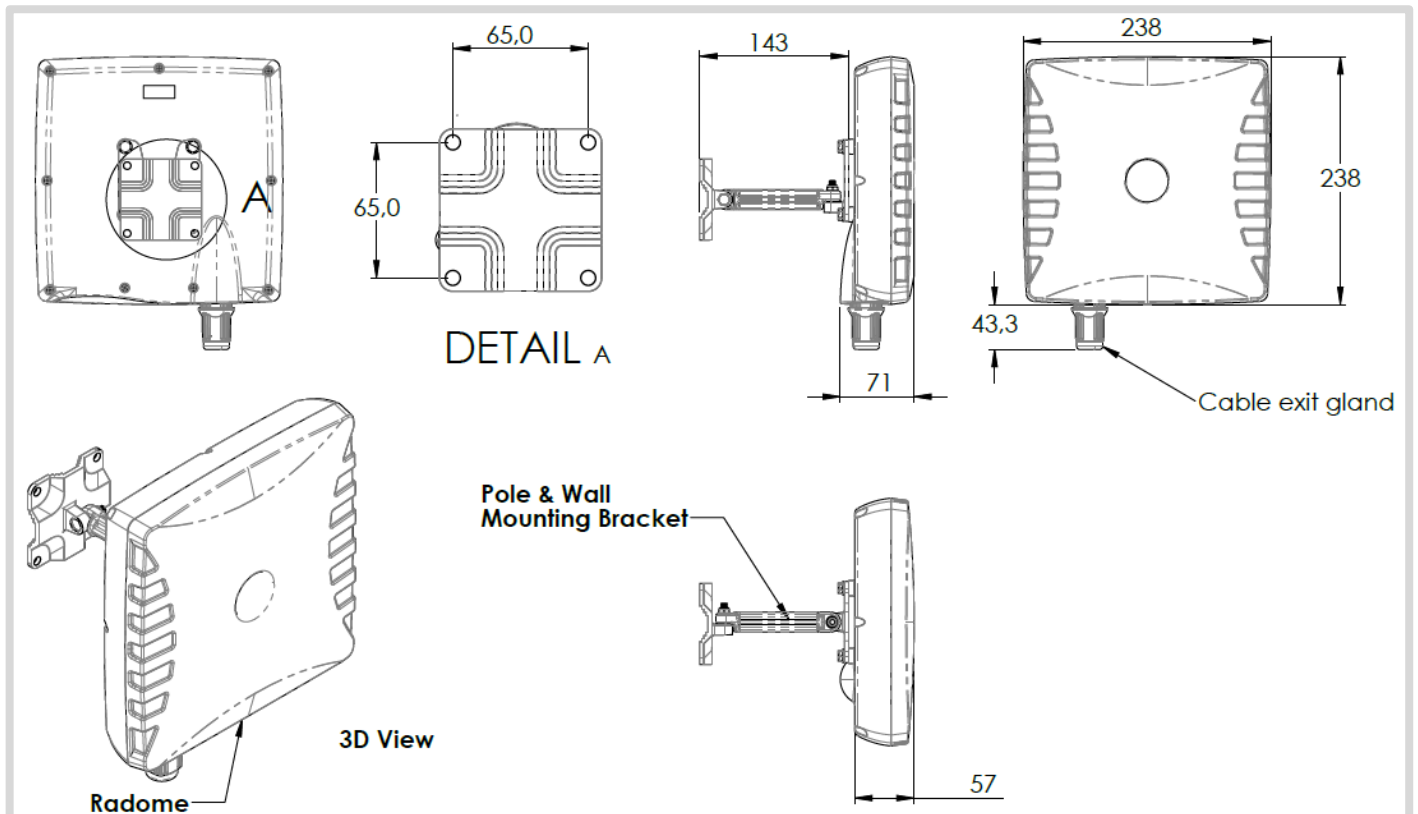

Radiation Patterns

Azimuth: 2400 – 2500 MHz

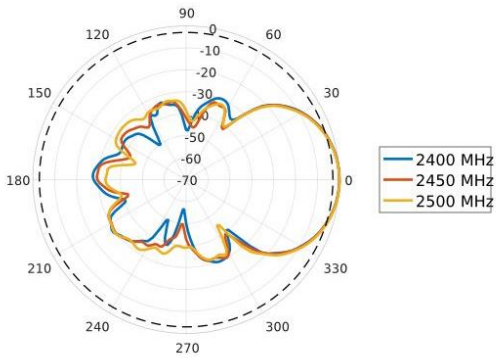

Azimuth: 3300 – 3800 MHz

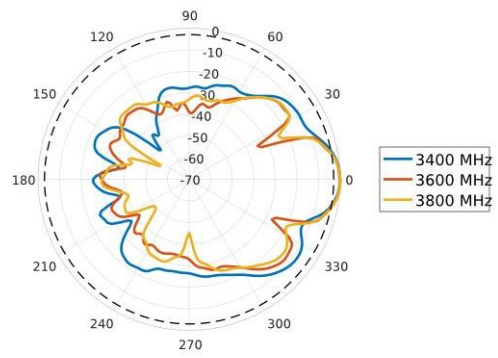

Azimuth: 5000 – 6000 MHz

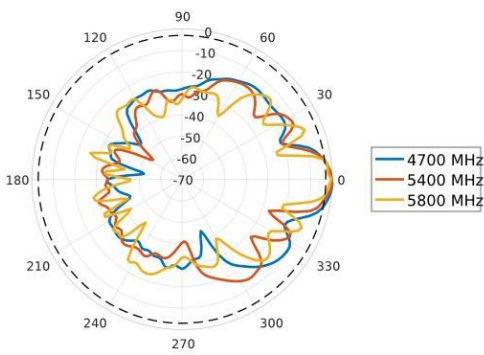

Elevation: 2400 – 2500 MHz

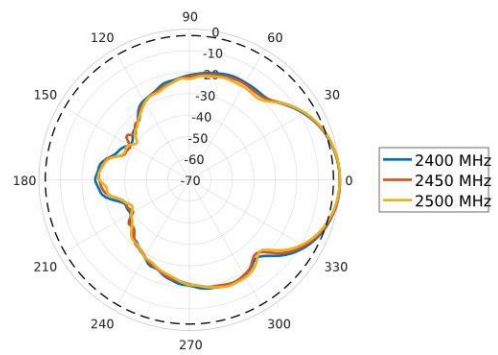

Elevation: 3300 – 3800 MHz

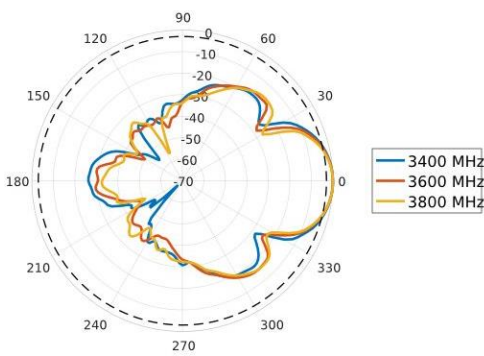

Elevation: 5000 – 6000 MHz

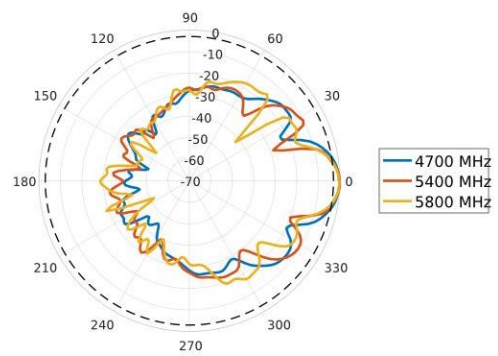

Mounting Options

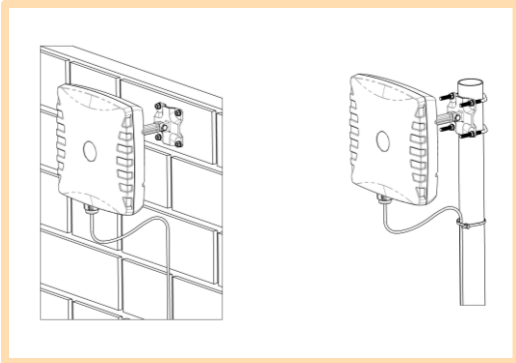

Pole Mount

Wall/pole mount bracket included

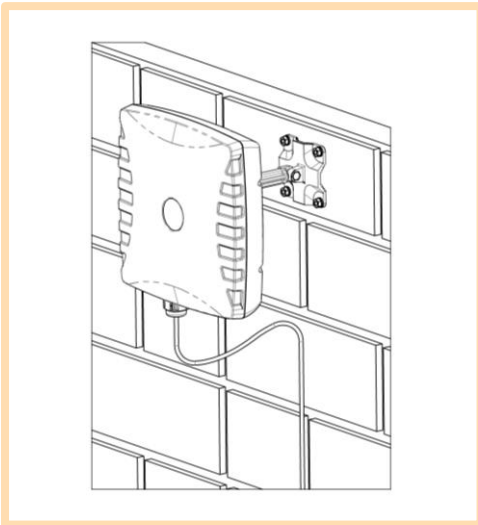

Wall Mount

Wall/pole mount bracket included

Additional Accessories

Extension Cables: Up to 15m HDF 195
Various connectors available
Installation poles and brackets available

See accessories technical specifications on www.poynting.tech

Contact Poynting

Poynting Antennas (Pty) Ltd - Head Office

Unit 4, N1 Industrial Park
Landmarks Avenue,
Samrand, 0157
South Africa

Phone: +27 (0) 12 657 0050

E-mail: sales@poynting.co.za

Poynting Europe

Regus Business Center Neue Messe Riem
Kronstadter Straße 4
81677 München
Germany

Phone: +49 89 208026538

E-mail: sales-europe@poynting.tech

Poynting USA

1804 Owen Court, Suite 104,
Mansfield,
TX 76063
USA

Phone: +1 817 533-8130

E-mail: sales-us@poynting.tech