

## ANTENNAS | HELI-42 SERIES

# CIRCULAR POLARISED, BI-DIRECTIONAL MINE/TUNNEL WI-FI ANTENNA

2400 – 2500 MHz, 9.5dBi; 5000 – 6000 MHz, 13dBi

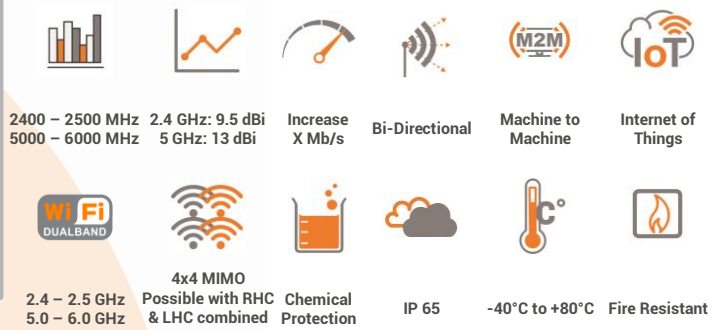
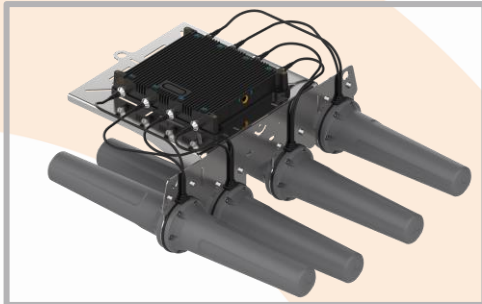

APPLICATION AREAS

- Circular Polarised HELI antenna provides enhanced signal propagation and connection stability within a tunnel
- Left-hand Circular (LHC) & Right-hand Circular (RHC) polarised
- Bi-directional – radiates in both directions in a tunnel
- Ruggedized & water ingress protected
- Ideal for Mining & Tunnel M2M and IoT deployments

## Product Overview

The HELI-42 forms part of the Mini-HELI antenna series. These antennas are only mini in size relative to their bigger brothers, the HELI-3, HELI-4 & HELI-8, but offer medium to high gain, which makes these antennas ideal for mining tunnels where IoT/M2M connectivity is deployed and can also be used for coverage into the stopes.

The HELI-42 is a dual-band 2.4 GHz and 5 GHz Wi-Fi antenna, radiating in both directions (i.e., bi-directional). This makes them ideal for the coverage of both Wi-Fi bands in mining and other type of tunnels. These antennas are typically used for the deployment of IoT within the tunnel to provide telemetry and mining automation. These antennas are available in both Left-hand Circular (LHC) & Right-Hand Circular (RHC) polarised antenna elements to provide optimal decorrelation within a 4x4 MIMO or even 8x8 MIMO deployment when using the BRKT-46, resulting in optimum performance. The antenna decorrelation is due to the polarisation difference and spatial diversity, between the two antenna elements, which enhances MIMO performance and RF reliability within a mining tunnel. The dual-band Wi-Fi connection propagates around tunnel bends in a Non-Line of Sight scenario and provides immunity to many Wi-Fi signal disrupting objects such as trains and drilling machinery which appear to obscure the tunnel.

## Features

- Eight port 2.4 GHz and 5 GHz Wi-Fi antenna
- This antenna is especially designed for mining and other types of tunnels where rapid extension of network is required
- Bi-directional – radiates in both directions in a tunnel
- Left & Right-hand Circular Polarised

## Application Areas

- Supplementing fibre/leaky feeder cable "Hotspots" to areas to enhance mobility or extend networks to inaccessible areas
- Underground telemetry and automation
- Creating of complete underground in tunnel wide data networks and internet/ LTE connectivity
- Seamless connection to personnel using cellular phones, smart devices and tablets



**Frequency Bands**

The HELI-42 is a Wi-Fi/ISM antenna that works from | 2400 – 2500 MHz | & | 5000 – 6000 MHz |

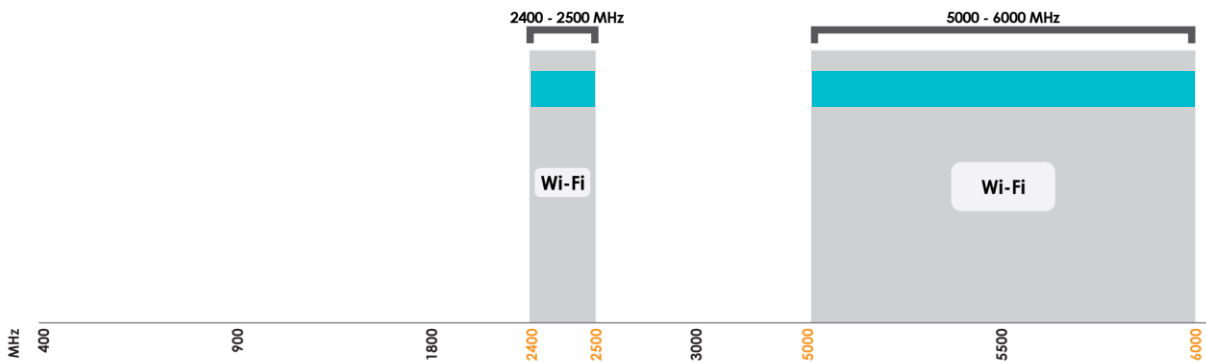

Indicates the WI-FI bands on which HELI-42 works

**Antenna Derivatives**

Product Order Code (SKU)	A-HELI-0042-V1-01	A-HELI-0042-V1-02
Ports	4	4
SISO / MIMO	4x4 MIMO	4x4 MIMO
Coax Cable Type	RG-141	RG-141
Coax Cable Length	400 mm	400 mm
Connector Type	N-Type (M)	N-Type (M)
Included Mounting Bracket	A-BRKT-046-V2-01	A-BRKT-046-V2-01 and A-BRKT-047-V2-01
EAN	6009710924112	6009710924136

*\*The coax cable & connector are factory mounted to the antenna*

## Electrical Specifications

<b>Frequency bands:</b>	2400 – 2500 MHz 5000 – 6000 MHz
<b>Gain (max):</b>	2.4 GHz: 9.5 dBi 5 GHz: 13 dBi
<b>VSWR:</b>	<1.5:1
<b>Feed power handling:</b>	30 W
<b>Input impedance:</b>	50 Ohm (nominal)
<b>Polarisation:</b>	Circular Polarised (LHC or RHC)
<b>Coax cable loss:</b>	0.821 dB/m @ 2.4 GHz 1.42 dB/m @ 5.8 GHz
<b>DC short:</b>	N/A

## Product Box Contents

<b>Antenna:</b>	2 x A-HELI-0019-V2-01-R 2 x A-HELI-0019-V2-01-L
<b>Mounting bracket:</b>	A-BRKT-046-V2-01

## Mechanical Specifications

<b>Product dimensions</b>	570 mm x 680 mm x 289 mm
<b>Packaged dimensions:</b>	580 mm x 750 mm x 390 mm
<b>Weight:</b>	8.44kg
<b>Packaged weight:</b>	11.65kg
<b>Radome material:</b>	UV Stable ASA
<b>Radome colour:</b>	Grey Pantone-424C
<b>Mounting Type:</b>	Ceiling Mounted

## Environmental Specifications, Certification & Approvals

<b>Wind Survival:</b>	≤120 km/h
<b>Temperature Range (Operating):</b>	-40°C to +80°C
<b>Environmental Conditions:</b>	Outdoor/Indoor
<b>Water ingress protection ratio/standard:</b>	IP 65
<b>Salt Spray:</b>	MIL-STD 810G/ASTM B117
<b>Operating Relative Humidity:</b>	Up to 98%
<b>Storage Humidity:</b>	5% to 95% - non-condensing
<b>Storage Temperature:</b>	-40°C to +80°C
<b>Enclosure Flammability Rating:</b>	UL 94-HB
<b>Impact resistance:</b>	IK 08
<b>Product Safety &amp; Environmental:</b>	Complies with CE and RoHS standards



**Antenna Performance Plots**

**VSWR: 2400 – 2500 MHz**

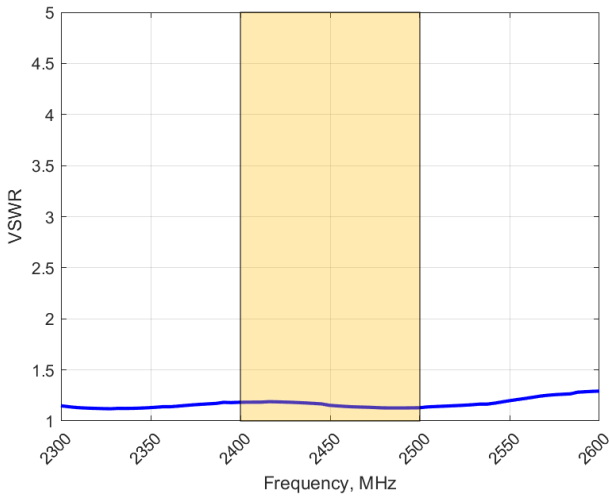

**Voltage Standing Wave Ratio (VSWR)\***

VSWR is a measure of how efficiently radio-frequency power is transmitted from a power source, through a transmission line, into a load. In an ideal system, 100% of the energy is transmitted which corresponds to a VSWR of 1:1.

The HELI-42 delivers superior performance across the band with a VSWR of <1.5:1.

\*VSWR measured with 400mm low loss cable.

**VSWR: 5000 – 6000 MHz**

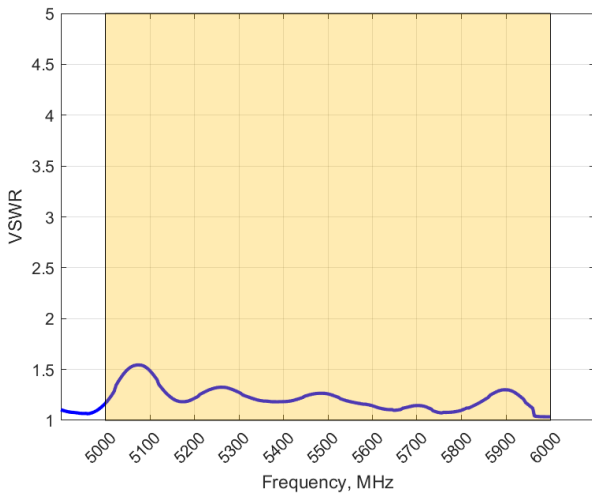

**Voltage Standing Wave Ratio (VSWR)\***

VSWR is a measure of how efficiently radio-frequency power is transmitted from a power source, through a transmission line, into a load. In an ideal system, 100% of the energy is transmitted which corresponds to a VSWR of 1:1.

The HELI-42 delivers superior performance across the band with a VSWR of 1.5:1 or better.

\*VSWR measured with 400mm low loss cable.

**GAIN (EXCLUDING CABLE LOSS): 2400 – 2500 MHz**

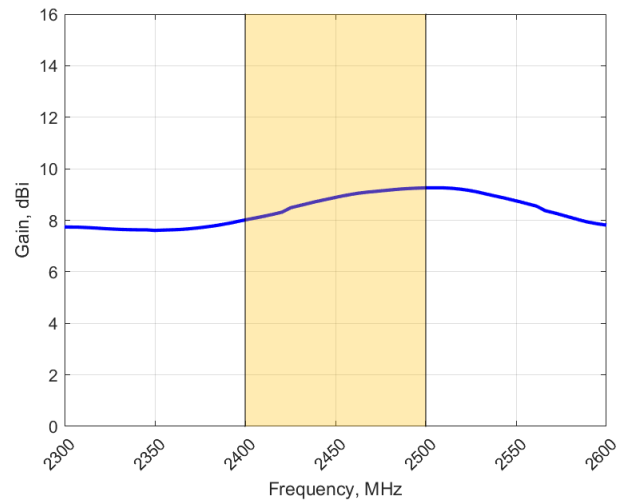

**Gain\* in dBi**

9.5 dBi is the peak gain across from 2400 – 2500 MHz

\*Antenna gain measured with polarisation aligned standard antenna

**GAIN (EXCLUDING CABLE LOSS): 5000 – 6000 MHz**

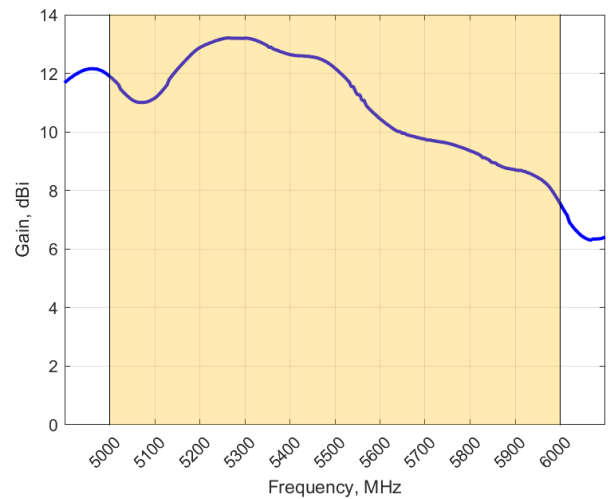

**Gain\* in dBi**

13 dBi is the peak gain from 5000 – 6000 MHz

\*Antenna gain measured with polarisation aligned standard antenna

Technical Drawings

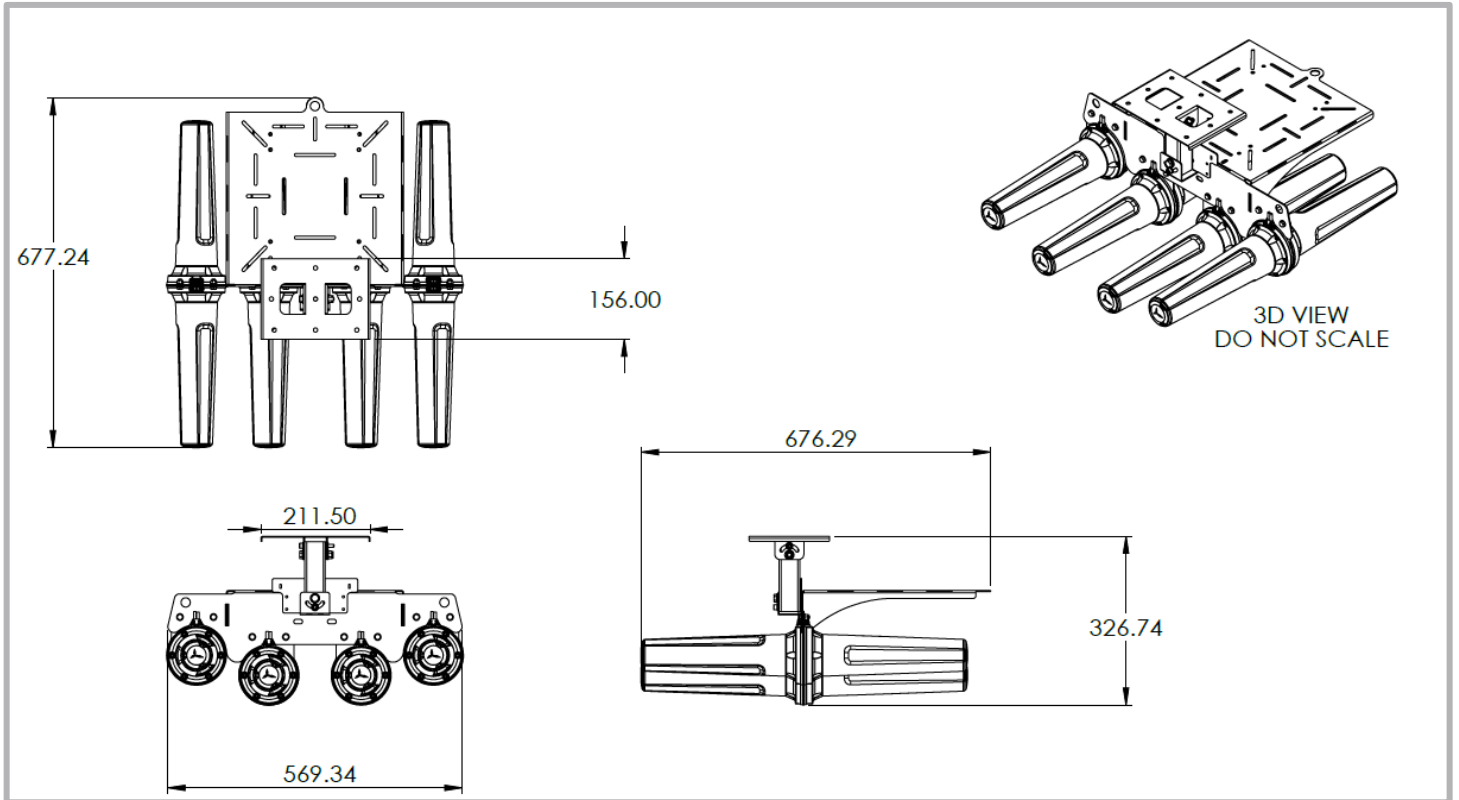

**Radiation Patterns**

**Azimuth: 2400 – 2500 MHz**

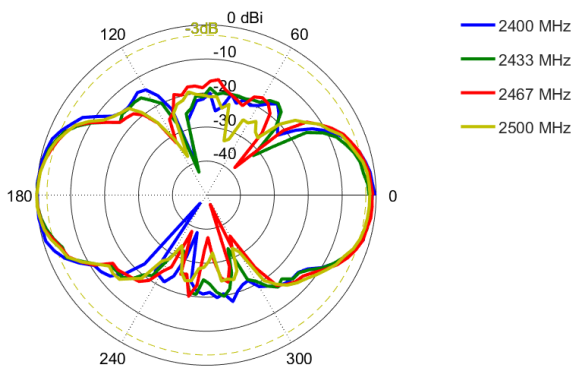

**Azimuth: 5000 – 6000 MHz**

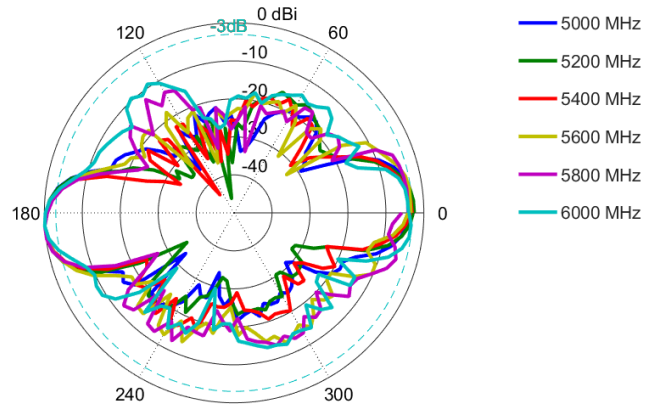

**Elevation: 2400 – 2500 MHz**

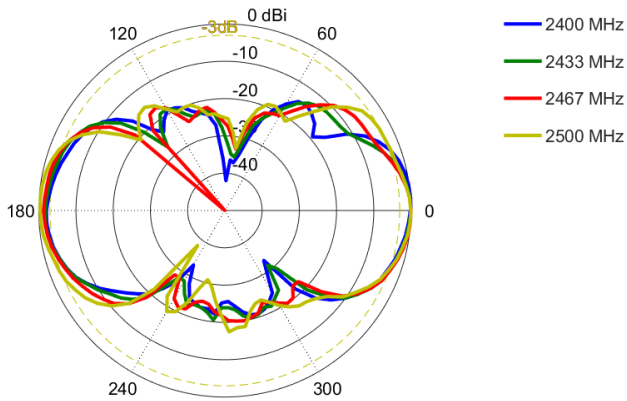

**Elevation: 5000 – 6000 MHz**

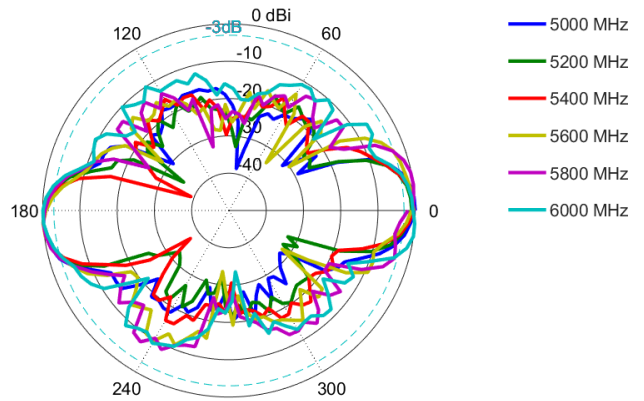

## Mounting Options

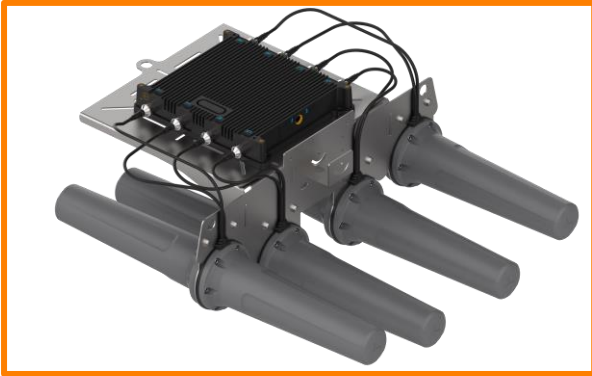

### Ceiling Mount

Mining Tunnel Roof Mount Bracket for 4x Mini-HELI Antennas.

This option uses A-BRKT-046-V2-01.



### Roof Bolt Mounting

This optional 20mm roof bolt mounting bracket attachment is used in conjunction with BRKT-46 for mounting to standard mine roof bolts.

This option uses A-BRKT-047-V2-01.

---

## Additional Accessories

See accessories technical specifications on [www.poynting.tech](http://www.poynting.tech)



---

## CONTACT POYNTING

### Poynting Antennas (Pty) Ltd - Head Office

Unit 4, N1 Industrial Park,  
Landmarks Avenue,  
Samrand, 0157, South Africa

**Phone:** +27 (0) 12 657 0050

**E-mail:** [info@poynting.tech](mailto:info@poynting.tech)

**International Email:** [sales-global@poynting.tech](mailto:sales-global@poynting.tech)

### Poynting Europe

Regus Business Center Neue Messe Riem  
Kronstadter Straße 4  
81677 München  
Germany

**Phone:** +49 89 7453 9002

**E-mail:** [sales-europe@poynting.tech](mailto:sales-europe@poynting.tech)

### Poynting USA

1804 Owen Court, Suite 104,  
Mansfield,  
TX 76063  
USA

**Phone:** +1 817 533-8130

**E-mail:** [sales-us@poynting.tech](mailto:sales-us@poynting.tech)