











ANTENNAS | HELI-11 SERIES

CIRCULAR POLARISED, DIRECTIONAL MINE/TUNNEL ANTENNA

Wi-Fi; 2400 – 2500 MHz, 12 dBi



| | | | | | |
|---|---|---|--|---|---|
|  |  |  |  |  |  |
| 2400 – 2500 MHz | 12 dBi | Uni-Directional | 2.4 – 2.5 GHz | IoT | Machine to Machine |
|  |  |  |  |  | |
| 2x2 MIMO possible with RHC & LHC | IP 65 | Chemical Protection | -40°C to +80°C | Fire Resistant | |



Mining



Tunnelling



Mining and Surface

APPLICATION AREAS

- Circular Polarised HELI antenna provides enhanced signal propagation and connection stability within a tunnel
- Left-Hand Circular (LHC) & Right-Hand Circular (RHC) Polarised options available
- Uni-directional – radiates in one direction in a tunnel
- Ruggedized water and dust ingress protected (IP 65)
- Ideal for Mining & Tunnel M2M and IoT deployments

Product Overview

The HELI-11 forms part of a series of Mini-HELI antennas. These antennas are only mini in size relative to their bigger brothers, the HELI-3, HELI-4 and HELI-8 but offer medium to high gain, which makes these antennas ideal for mining tunnels where IoT/M2M connectivity is deployed and can also be used for coverage into the stopes.

The HELI-11 is a 2.4 GHz Wi-Fi antenna, radiating in one direction (i.e., Uni-directional), which makes it ideal for the coverage of the 2.4 GHz in mining and other types of tunnels. These antennas are typically used for the deployment of IoT within the tunnel to provide telemetry and mine automation. These antennas are available in both Left-Hand Circular (LHC) & Right-Hand Circular (RHC) polarised antenna elements to provide optimal decorrelation within a MIMO deployment when using the BRKT-45, resulting in optimum performance. The decorrelation is due to the polarisation difference and spatial diversity, between the two antenna elements, which enhances MIMO performance and RF reliability within a mining tunnel. The Wi-Fi connection propagates around tunnel bends in a Non-Line of Sight scenario and provides immunity to many Wi-Fi signal disrupting objects such as trains and drilling machinery which appear to obscure the tunnel.

Features

- Single port 2.4 GHz antenna
- This antenna is especially designed for mining and other types of tunnels where extension of network is required
- Uni-directional – radiates in one direction in a tunnel
- Left & Right-Hand Circular Polarised available (for MIMO)
- Intrinsically safe version available on request

Application Areas

- Supplementing fibre/leaky feeder cable “Hotspots” to areas to enhance mobility or extend networks to inaccessible areas
- Underground telemetry and automation
- Creating of complete underground in tunnel wide data networks and internet/LTE connectivity
- Seamless connection to personnel using cellular phones and smart devices and tablets



2x HELI-11 antennas mounted on the BRKT-45 for MIMO application

HELI-11



Frequency Bands

The Heli-11 is a Wi-Fi / ISM antenna that works from | 2400 – 2500 MHz |

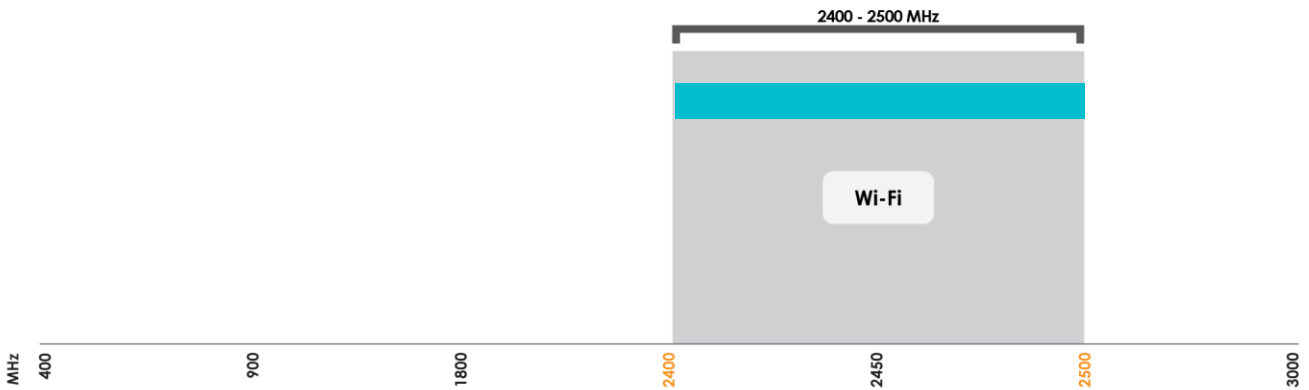

Indicates the Wi-Fi bands on which Heli-11 works

Antenna Overview

| | |
|---|--|
| |  |
| Ports | 1 |
| Frequency Bands | 2400 – 2500 MHz |
| Peak Gain | 12 dBi |
| Coax Cable Type | RG-141 |
| Coax Cable Length | 400mm |
| Connector Type | N-Type (M) |
| <i>*The coax cable & connector are factory mounted to the antenna</i> | |

Electrical Specification

| | |
|----------------------|---------------------------------|
| Frequency Bands: | 2400 – 2500 MHz |
| Gain (Max): | 12 dBi |
| VSWR: | ≤1.5:1 |
| Feed Power Handling: | 30 W |
| Input Impedance: | 50 Ohm (nominal) |
| Polarisation: | Circular Polarised (LHC or RHC) |
| Coax Cable Loss: | 0.84 dB /m @ 2.4 GHz |
| DC Short: | N/A |

Product Box Content

| | |
|----------|-------------------|
| Antenna: | A-HELI-0011-V3-01 |
|----------|-------------------|

Ordering Information

| | |
|--------------------------------|---------------------|
| Commercial name: | HELI-11 |
| a) Right-hand Circular Version | |
| Order product code: | A-HELI-0011-V3-01-R |
| EAN number: | 6009710921326 |
| b) Left-hand Circular Version | |
| Order product code: | A-HELI-0011-V3-01-L |
| EAN number: | 6009710921319 |

Note: For MIMO application, order both Right-Hand Circular and Left-Hand Circular antennas.

Mechanical Specification

| | |
|----------------------|--------------------------|
| Product Dimensions: | 318 mm x 143 mm x 116 mm |
| Packaged Dimensions: | 360 mm x 165 mm x 140 mm |
| Weight: | 0.35 kg |
| Packaged Weight: | 0.85 kg |
| Radome Material: | UV Stable ASA |
| Radome Colour: | Grey Pantone-424C |
| Mounting Type: | Ceiling mounted |

Environmental Specifications, Certification & Approvals

| | |
|--|-------------------------------------|
| Wind Survival: | ≤120 km/h |
| Temperature Range (Operating): | -40°C to +80°C |
| Environmental Conditions: | Outdoor/Indoor |
| Water Ingress Protection Ratio/Standard: | IP 65 |
| Salt Spray: | MIL-STD 810G/ASTM B117 |
| Operating Relative Humidity: | Up to 98% |
| Storage Humidity: | 5% to 95% - non-condensing |
| Storage Temperature: | -40°C to +80°C |
| Enclosure Flammability Rating: | UL 94-HB |
| Impact Resistance: | IK 08 |
| Product Safety & Environmental: | Complies with CE and RoHS standards |



Antenna Performance Plots

VSWR

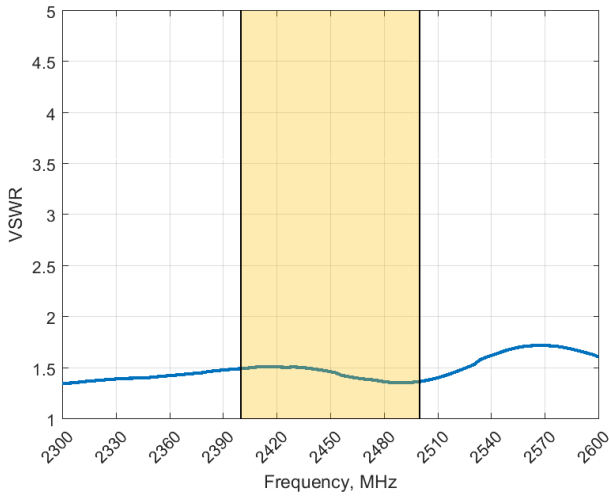

Voltage Standing Wave Ratio (VSWR)*

VSWR is a measure of how efficiently radio-frequency power is transmitted from a power source, through a transmission line, into a load. In an ideal system, 100% of the energy is transmitted which corresponds to a VSWR of 1:1.

The HELI-11 delivers superior performance across all bands with a VSWR of $\leq 1.5:1$.

*VSWR measured with 400mm low loss cable

GAIN (EXCLUDING CABLE LOSS)

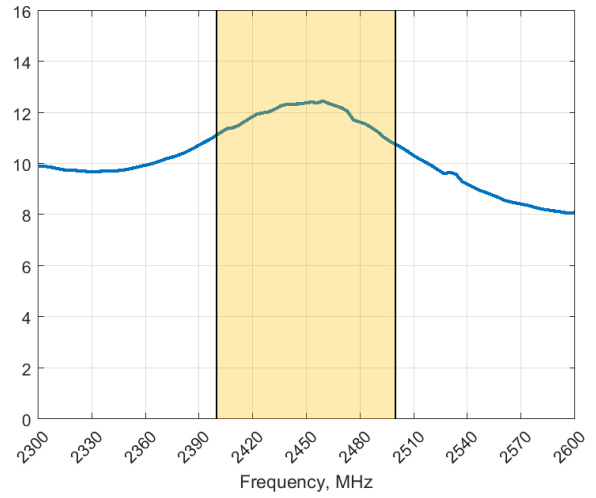

Gain* in dBi

12 dBi is the peak gain across all bands from 2400 – 2500 MHz

*Antenna gain measured with circular polarised standard antenna

Technical Drawings

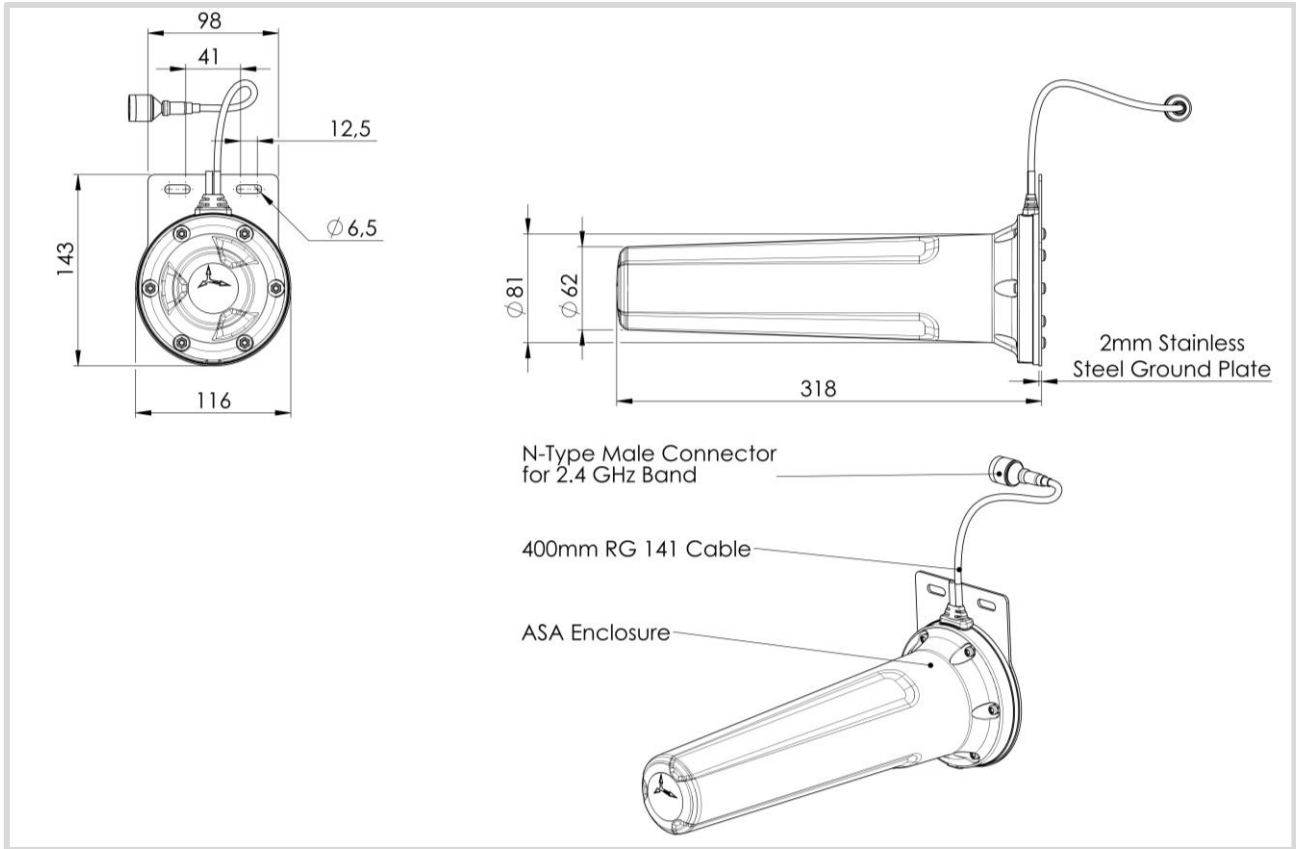

Radiation Patterns

Azimuth: 2400 – 2500 MHz

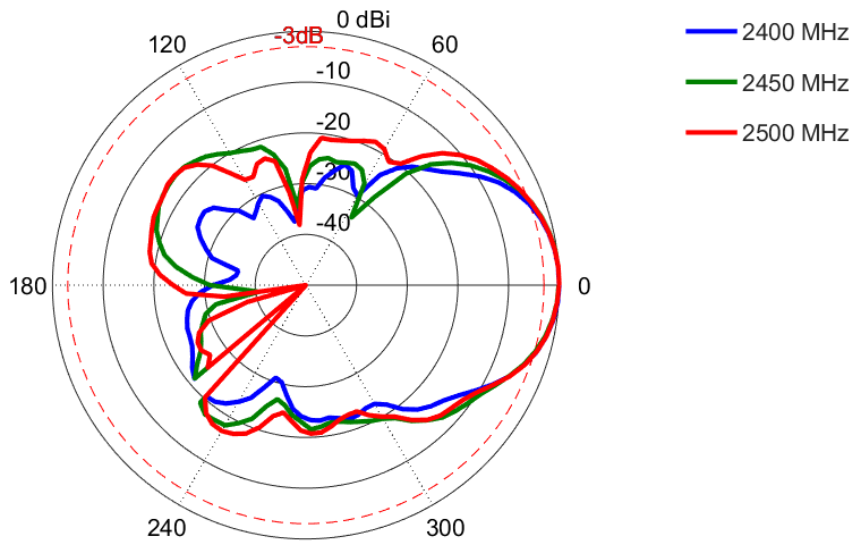

Elevation: 2400 – 2500 MHz

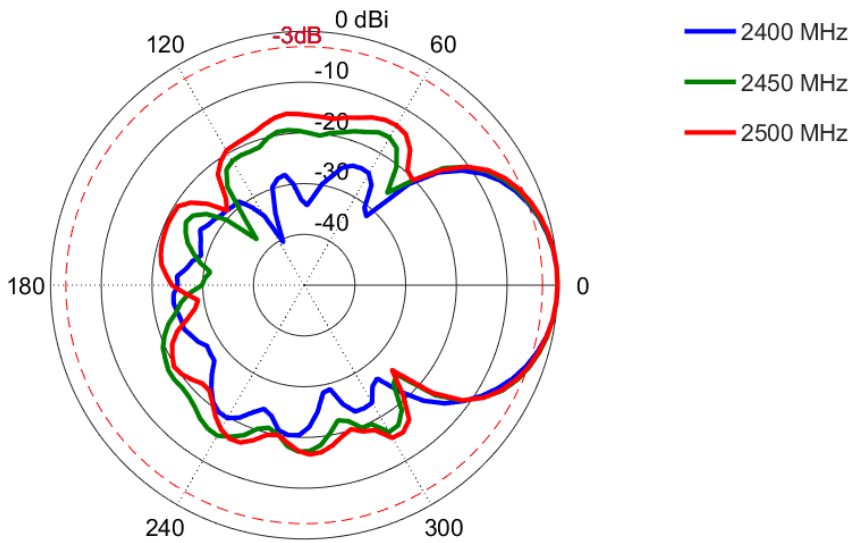

Mounting Options



Base Mount

The antenna can be fastened directly using the two slots on its base, via an L-Bracket to a pipe or directly to another surface.

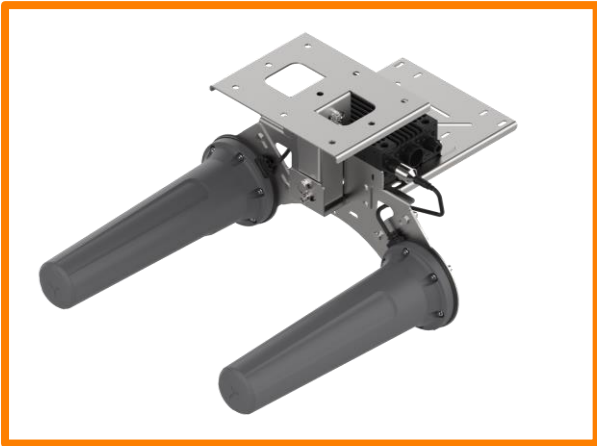

Ceiling Mount (MIMO) - Optional

An optional multi-directional swivel bracket is available for mounting 2 x miniHELI antennas (right-hand circular and left-hand circular polarised antennas) to a ceiling for MIMO application.

This option uses A-BRKT-045-V2-01.



Roof Bolt Mount (MIMO) - Optional

This optional 20mm roof bolt mounting bracket attachment is used in conjunction with BRKT-45 for mounting to standard mine roof bolts.

This option uses A-BRKT-047-V1-01.

Additional Accessories



A – BRKT – 045 -V2 - 01

Ceiling mounting bracket for holding miniHELI right-hand and left-hand circular polarised antennas.

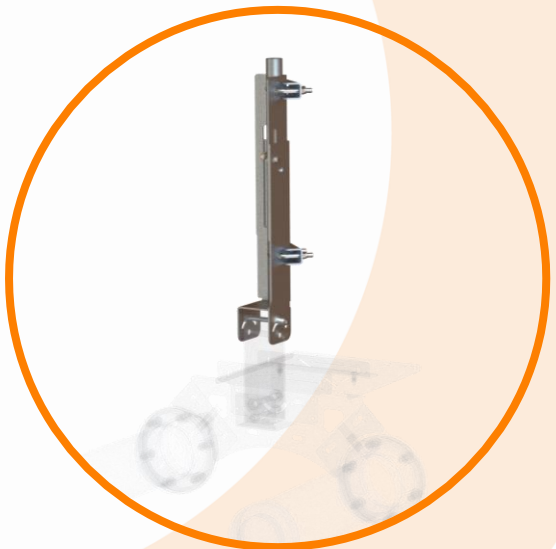

A – BRKT – 047 -V1 - 01

Ceiling 20mm Rod mounting bracket attachment to use with BRKT-45.

See accessories technical specifications on www.poynting.tech

CONTACT POYNTING

Poynting Antennas (Pty) Ltd - Head Office

Unit 4, N1 Industrial Park,
Landmarks Avenue,
Samrand, 0157, South Africa

Phone: +27 (0) 12 657 0050

E-mail: info@poynting.tech

International Email: sales-global@poynting.tech

Poynting Europe

Regus Business Center Neue Messe Riem
Kronstadter Straße 4
81677 München
Germany

Phone: +49 89 7453 9002

E-mail: sales-europe@poynting.tech

Poynting USA

1804 Owen Court, Suite 104,
Mansfield,
TX 76063
USA

Phone: +1 817 533-8130

E-mail: sales-us@poynting.tech